

SPECIFICATIONS:

TIMBER TRUSS GABLES

MATERIAL AND QUALITY ASSURANCE. Structural glue laminated timber shall be in conformance with AITC Standard (latest edition).
 Species: Laminating lumber shall be kiln-dried, architectural grade, sealed and wrapped. The roof system for wood structures and buildings are designed to withstand 30 PSF live load and 20 PSF wind load. Please check local codes. For heavier load requirements, please consult with Cedar Forest Products Company. The standard roof slope shall be 4/12.

LAMINATED SUPPORT COLUMNS

MATERIAL AND QUALITY ASSURANCE. Structural glue laminated timber shall be in conformance with AITC (latest edition). Species: Laminating lumber shall be kiln-dried Port Orford Cedar, architectural appearance grade. Laminated columns shall be sized to suit loading requirements. Manufacturers shall furnish connection steel and hardware for joining structural glue laminated timber members to their supports, exclusive of anchorage and embedment in masonry or concrete (anchor bolts are not furnished).

CONNECTOR PLATES

Plates shall be fabricated from structural steel ASTM-A-36.
 Plates to be Powder Coated Black.
 Hardware: A-325 zinc plated machine bolts and nuts.

ROOF DECKING

2" x 6" (nominal), #1 grade, single tongue and groove with V-joint on bottom face, kiln dried southern yellow pine, maximum moisture content shall be 19% or less selected for decking. Specified lengths, with all joints over supports.

GABLE END VERT BOARD

1" x 8" (nominal), single tongue and groove with V-joint on outside face, cedar.

SHINGLES

Class "A" fire rated, architectural grade, laminated fiberglass shingle with a 30 year limited warranty. To be installed, over 30 lb. felt. Roof application as per manufacturer's specifications. Color to be approved by owner/design professional.

FASCIA

2x8nom A.Y.Cedar, "D"/ Better Grade, kiln-dried, Surfaced on Four Sides.

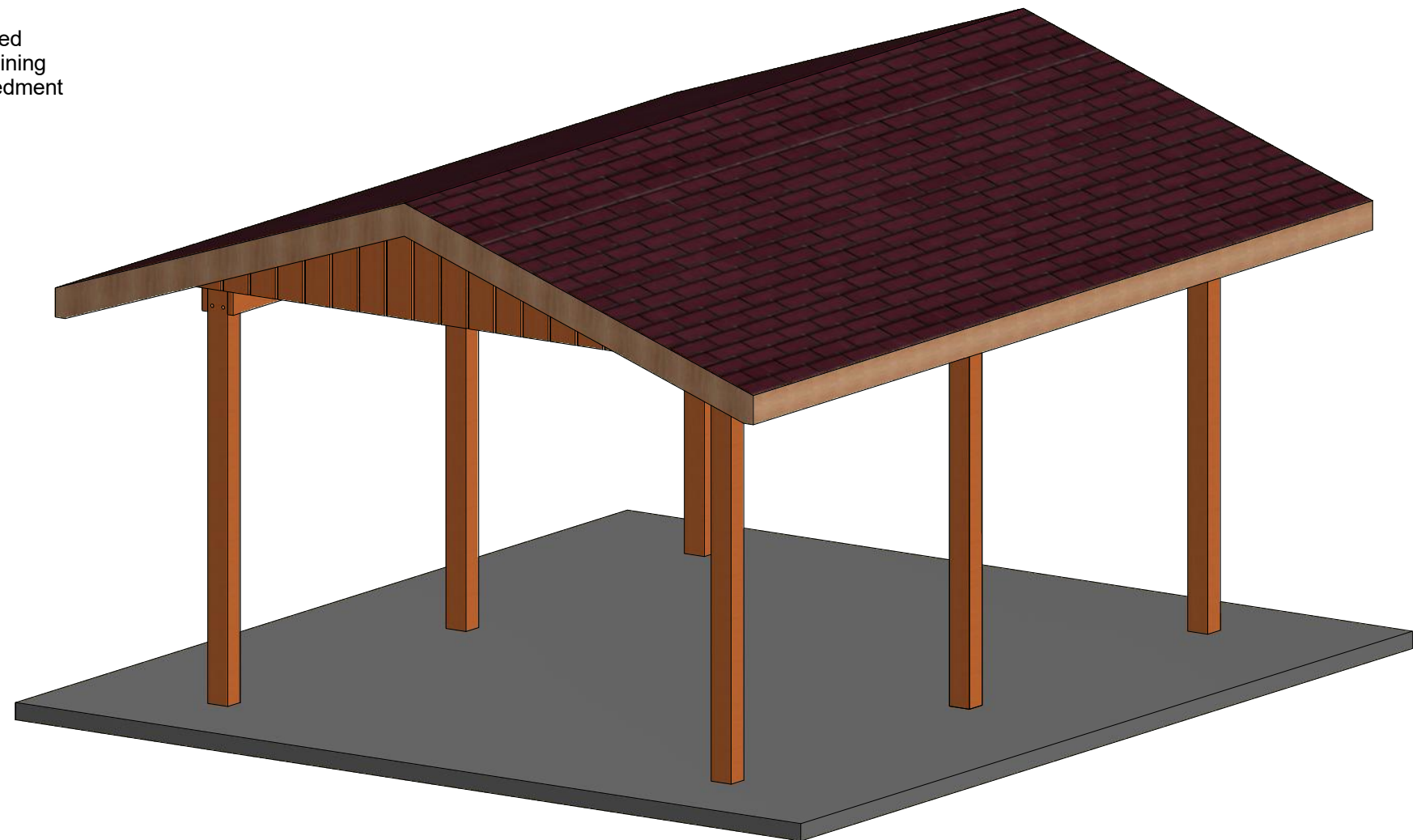

P.O. BOX 145
 WEST OLIVE, MI 49460
 800-552-9495

PRELIMINARY LAYOUT
NOT FOR CONSTRUCTION

DESCRIPTION:	MODEL #:	DATE:	JES DESIGN #:	REV:
16x20 Timber Truss	TT1620	2/7/2019	TT-STNRD	0

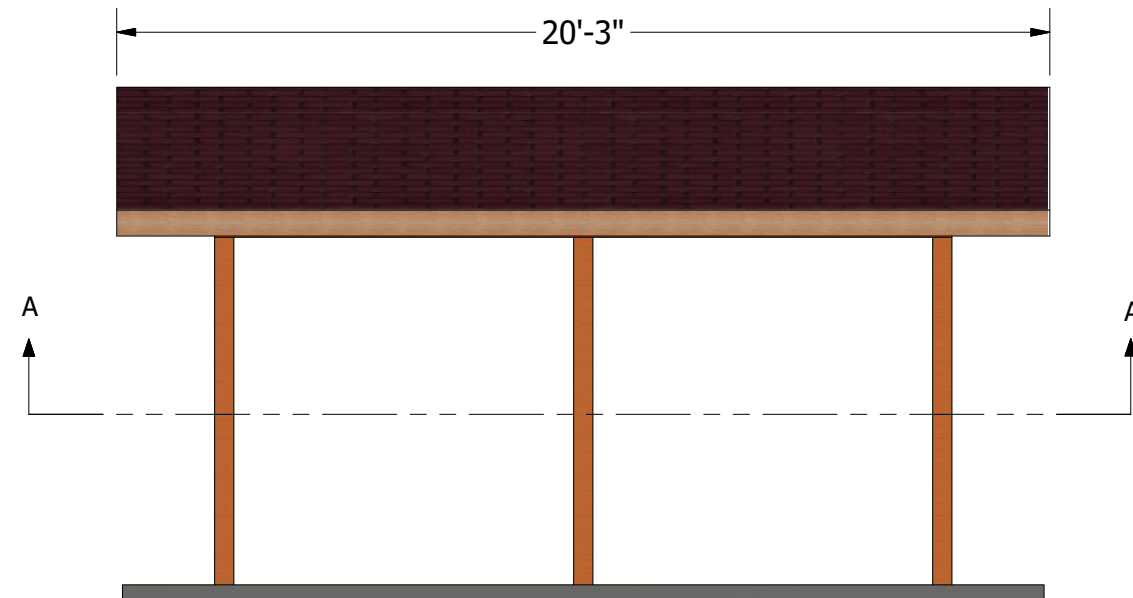
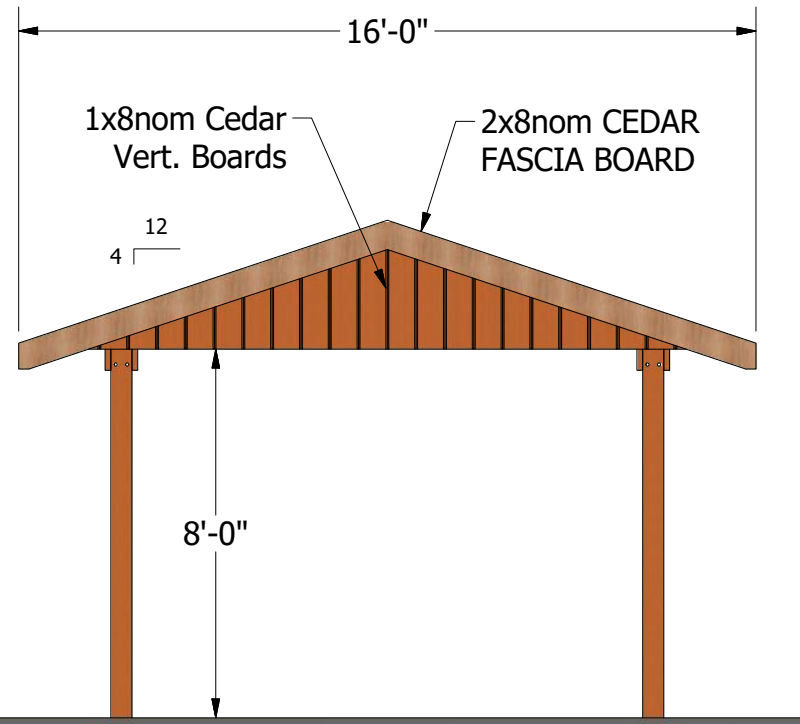
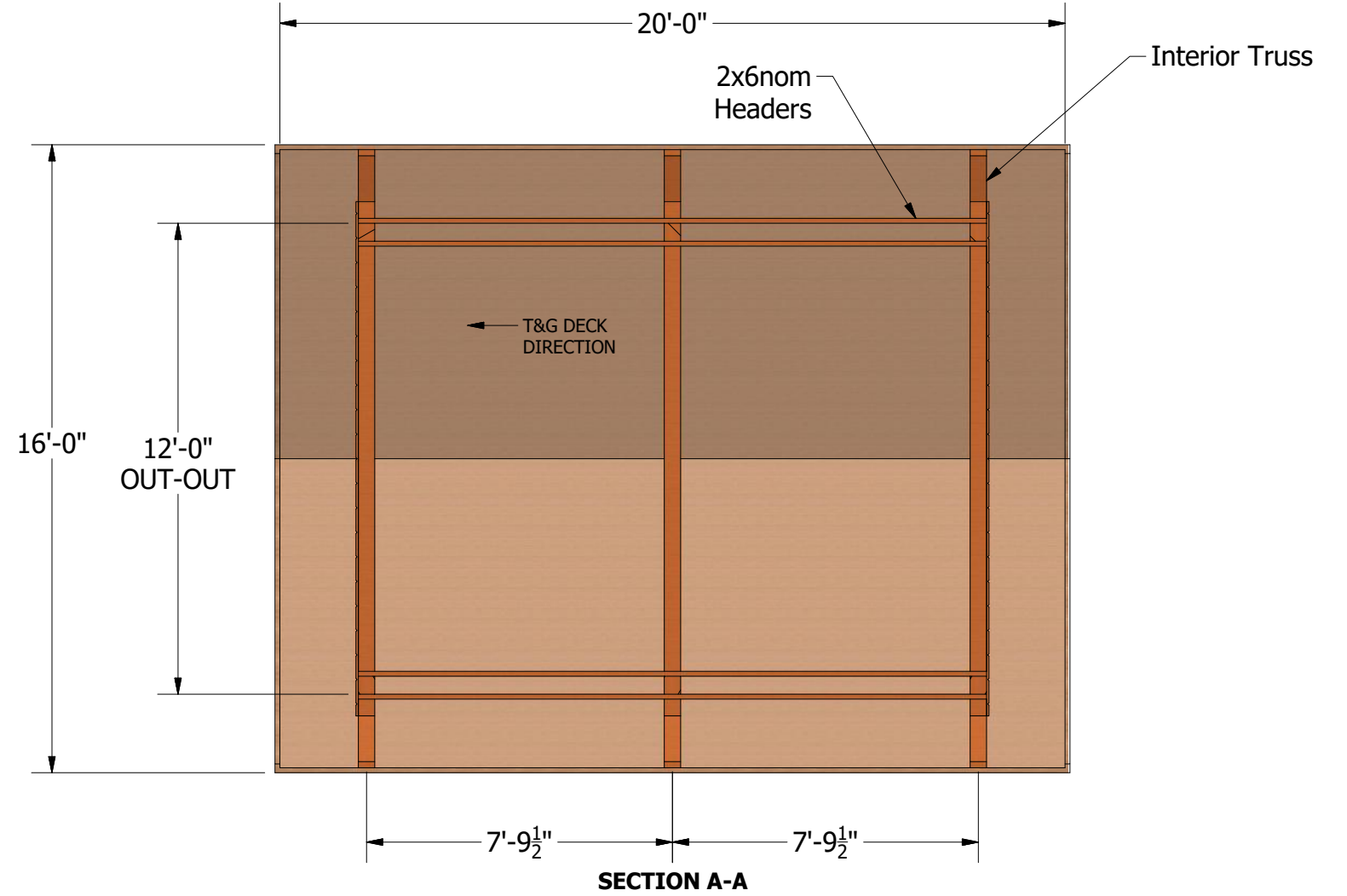
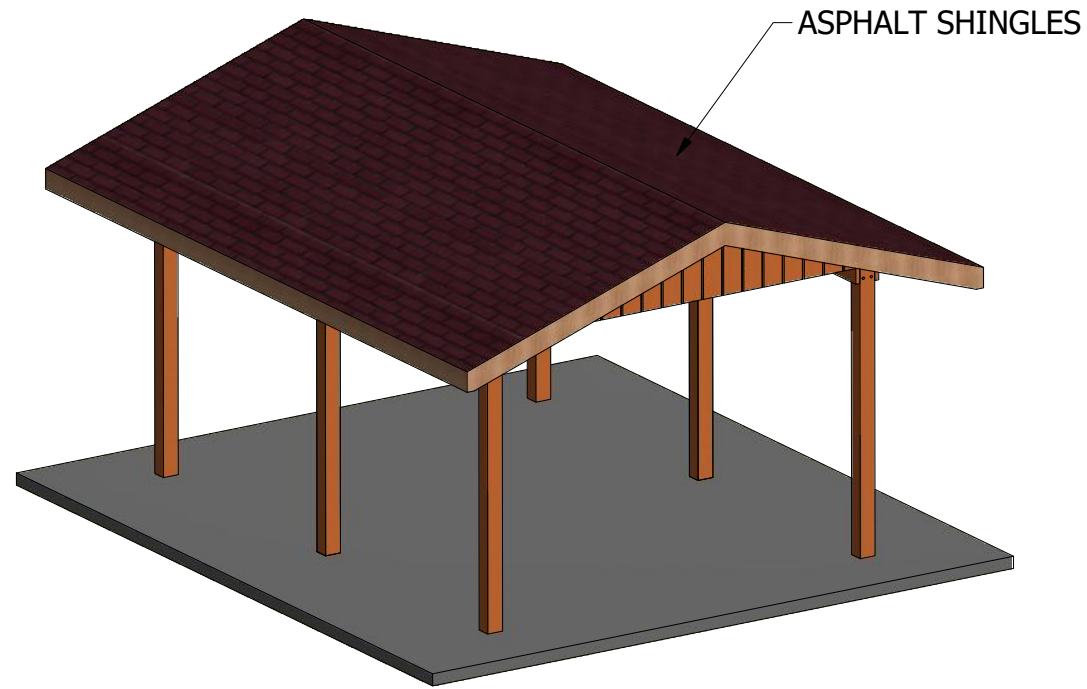

PRELIMINARY LAYOUT
NOT FOR CONSTRUCTION

DESCRIPTION: 16x20 Timber Truss	MODEL #: TT1620	DATE: 2/7/2019	JES DESIGN #: TT-STNRD	REV: 0
------------------------------------	--------------------	-------------------	---------------------------	-----------

STANDARD IN-GROUND



Column/Footing Detail
Final Size TBD
Concrete Pier By Others

OPTIONAL BASE SHOE

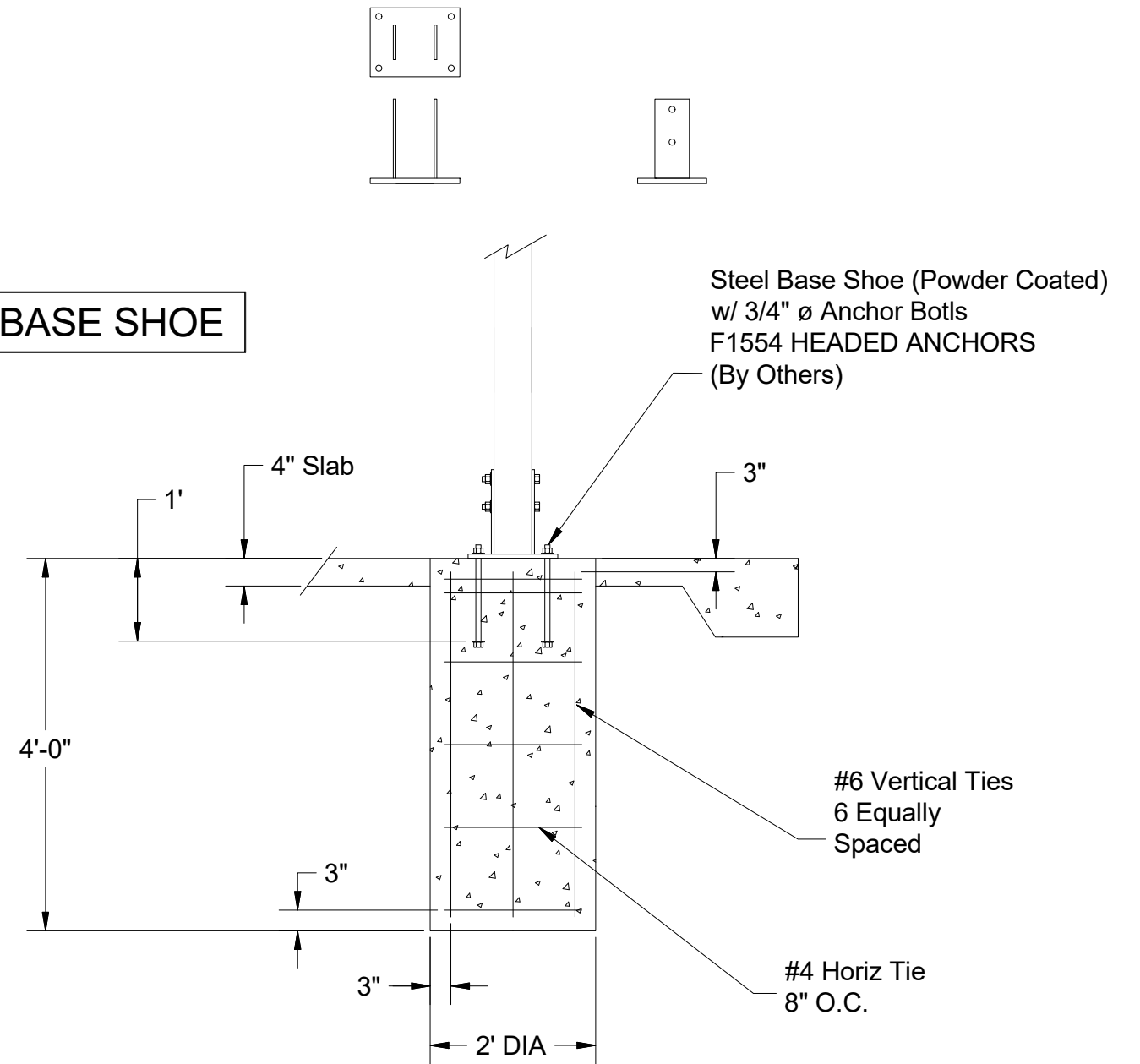

Column/Footing Detail
Final Size TBD
Concrete Pier By Others

PRELIMINARY LAYOUT
NOT FOR CONSTRUCTION

DESCRIPTION:	MODEL #:	DATE:	JES DESIGN #:	REV:
16x20 Timber Truss	TT1620	2/7/2019	TT-STNRD	0

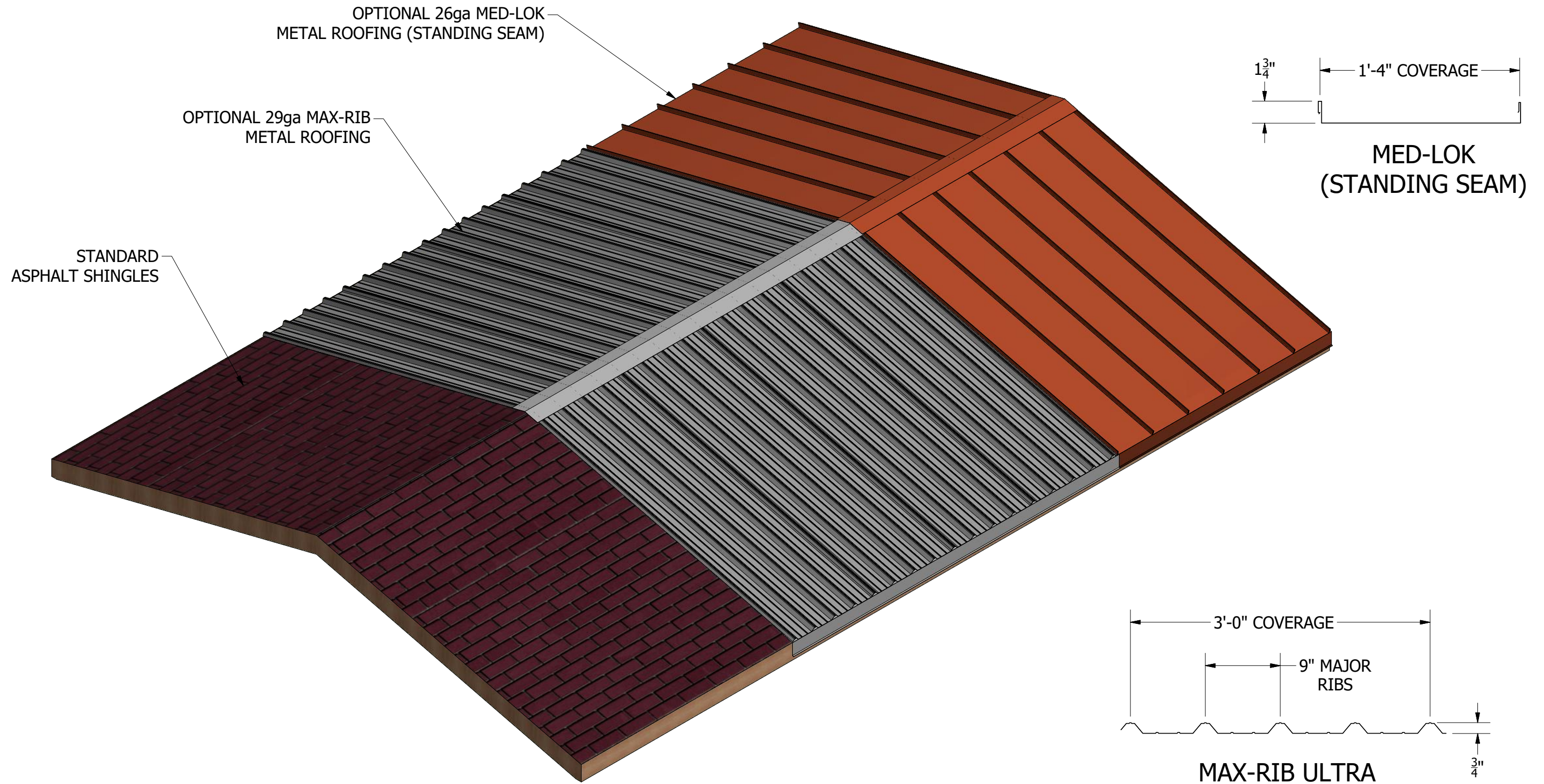

P.O. BOX 145
 WEST OLIVE, MI 49460
 800-552-9495
 WWW.CEDARFORESTPRODUCTS.COM

PRELIMINARY LAYOUT
NOT FOR CONSTRUCTION

MODEL #: OPTIONS
 TT(SIZE) = With Standard Asphalt Shingles
 TT(SIZE)-MR = With Max-Rib Metal Roof
 TT(SIZE)-SS = With Med-Lok Standing Seam Metal Roof

DESCRIPTION:	MODEL #:	DATE:	JES DESIGN #:	REV:
16x20 Timber Truss	TT1620	2/7/2019	TT-STNRD	0